

**FLAMESHIELD EVO 1 FIRE CURTAIN HEADBOX CONFIGURATION SECTIONS - SINGLE**

FLAMESHIELD  
STD 180 x 230mm

PRODUCT	MAX WIDTH (C)	MAX DROP (D)	FABRIC
FC	5000	4000	A1 STD
EW 120	5000	3500	A1 120

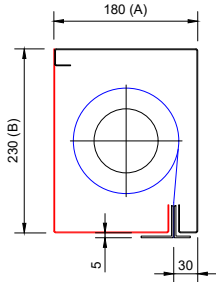

FLAMESHIELD  
STD 210 x 260mm

PRODUCT	MAX WIDTH (C)	MAX DROP (D)	FABRIC
FC	5000	6000	A1 STD
EW 120	5000	5000	A1 120

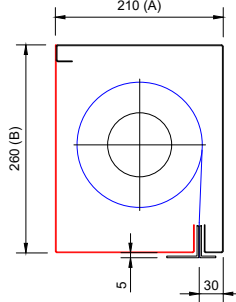

FLAMESHIELD  
STD 250 x 300mm

PRODUCT	MAX WIDTH (C)	MAX DROP (D)	FABRIC
FC	5000	8000	A1 STD
EW 120	5000	7000	A1 120

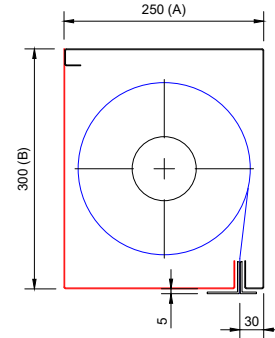

\* SIZES GREATER THAN STATED PLEASE CONTACT A1S

Drawing Title: FLAMESHIELD EVO 1 FIRE CURTAIN	Drawn By: DD
	Date: 18-11-2022
	Checked By: CE
	Date: 18-11-2022
All dimensions in millimetres - DO NOT SCALE	Drawing No: CD04R_01



A1 Shutters Limited  
Jackson Works  
Raikes Lane Industrial Estate  
Bolton BL3 2NH  
Telephone 01204 383839

**FLAMESHIELD EVO 1 FIRE CURTAIN GENERAL ARRANGEMENT DRAWING: REVEAL FIT**

**Key:**  
 Components supplied by A1S Group  
 Structure already in situ / or required by others  
 All openings must be capable of carrying the weight of the fire curtain and be equal or greater than the fire resistance of the fire curtain assembly.

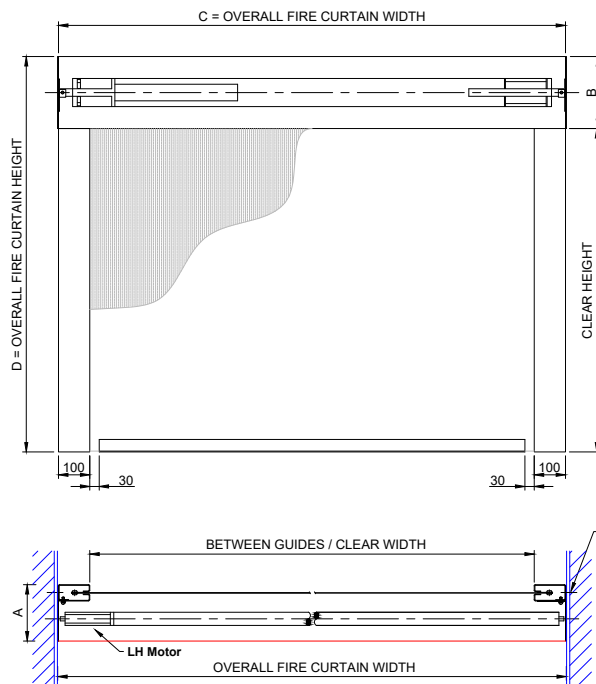

**CD04R**

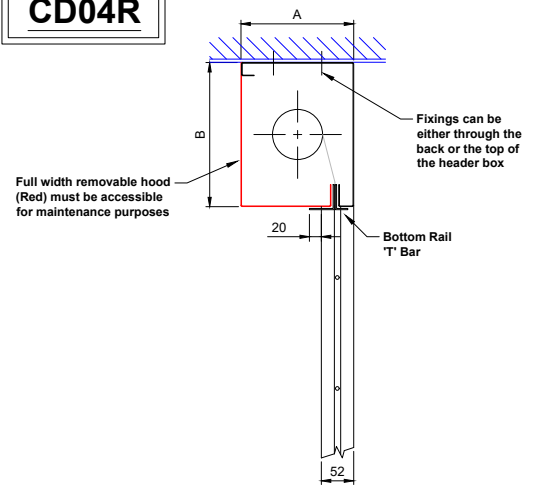

Full width removable hood (Red) must be accessible for maintenance purposes

Fixings can be either through the back or the top of the header box

Bottom Rail T Bar

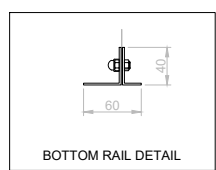

BOTTOM RAIL DETAIL

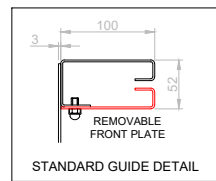

STANDARD GUIDE DETAIL

\* ADDITIONAL SIZES AVAILABLE SUBJECT TO ASSESSMENT

Drawing Title: FLAMESHIELD EVO 1 FIRE CURTAIN	Drawn By: DD
	Date: 18-11-2022
	Checked By: CE
	Date: 18-11-2022
All dimensions in millimetres - DO NOT SCALE	Drawing No: CD04R-02



A1 Shutters Limited  
Jackson Works  
Raikes Lane Industrial Estate  
Bolton BL3 2NH  
Telephone 01204 383839