

**FLAMESHIELD EVO 1 S FIRE CURTAIN HEADBOX CONFIGURATION SECTIONS - SINGLE**

FLAMESHIELD  
STD 180 x 230mm

PRODUCT	MAX WIDTH (C)	MAX DROP (D)	FABRIC
FC	5000	4000	A1 STD
EW 120	5000	3500	A1 120

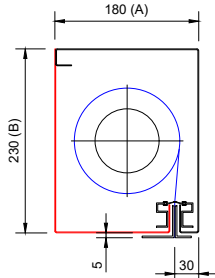

FLAMESHIELD  
STD 210 x 260mm

PRODUCT	MAX WIDTH (C)	MAX DROP (D)	FABRIC
FC	5000	6000	A1 STD
EW 120	5000	5000	A1 120

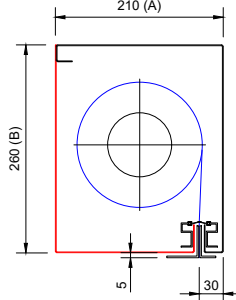

FLAMESHIELD  
STD 250 x 300mm

PRODUCT	MAX WIDTH (C)	MAX DROP (D)	FABRIC
FC	5000	8000	A1 STD
EW 120	5000	7000	A1 120

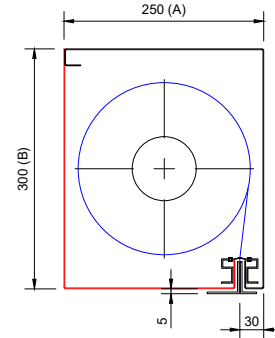

\* SIZES GREATER THAN STATED PLEASE CONTACT A1S

Drawing Title: FLAMESHIELD EVO 1 S FIRE CURTAIN	Drawn By: DD
	Date: 18-11-2022
	Checked By: CE
	Date: 18-11-2022
All dimensions in millimetres - DO NOT SCALE	Drawing No: CD05F.01



A1 Shutters Limited  
Jackson Works  
Raikes Lane Industrial Estate  
Bolton BL3 2NH  
Telephone 01204 383839

**FLAMESHIELD EVO 1 S FIRE CURTAIN GENERAL ARRANGEMENT DRAWING: FACE FIT**

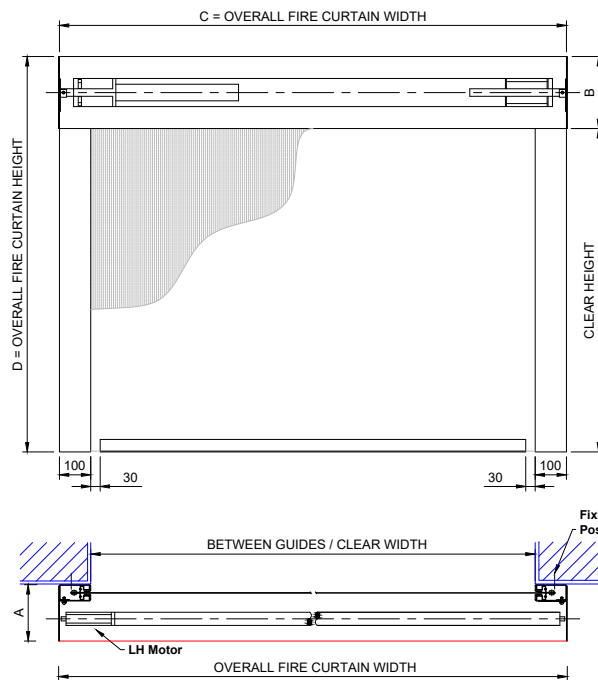

**CD05F**

**Key:**  
 — Components supplied by A1S Group  
 — Structure already in situ / or required by others  
 All openings must be capable of carrying the weight of the fire curtain and be equal or greater than the fire resistance of the fire curtain assembly.

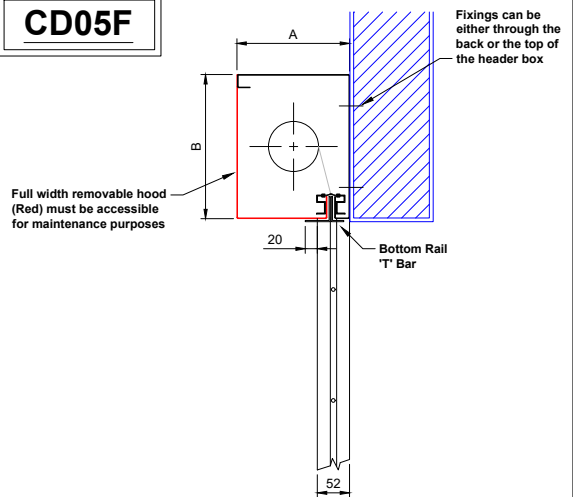

Full width removable hood (Red) must be accessible for maintenance purposes

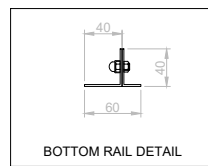

BOTTOM RAIL DETAIL

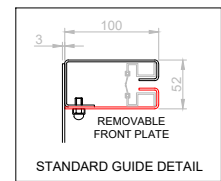

STANDARD GUIDE DETAIL

\* ADDITIONAL SIZES AVAILABLE SUBJECT TO ASSESSMENT

Drawing Title: FLAMESHIELD EVO 1 S FIRE CURTAIN	Drawn By: DD
	Date: 18-11-2022
	Checked By: CE
	Date: 18-11-2022
All dimensions in millimetres - DO NOT SCALE	Drawing No: CD05F-02



A1 Shutters Limited  
Jackson Works  
Raikes Lane Industrial Estate  
Bolton BL3 2NH  
Telephone 01204 383839