

FLAMESHIELD EVO 1 S FIRE CURTAIN HEADBOX CONFIGURATION SECTIONS - SINGLE

FLAMESHIELD
STD 180 x 230mm

PRODUCT	MAX WIDTH (C)	MAX DROP (D)	FABRIC
FC	5000	4000	A1 STD
EW 120	5000	3500	A1 120

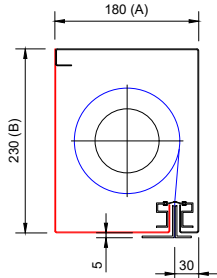

FLAMESHIELD
STD 210 x 260mm

PRODUCT	MAX WIDTH (C)	MAX DROP (D)	FABRIC
FC	5000	6000	A1 STD
EW 120	5000	5000	A1 120

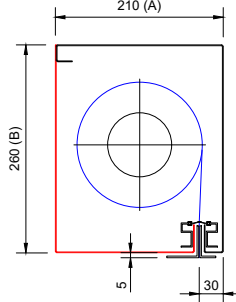

FLAMESHIELD
STD 250 x 300mm

PRODUCT	MAX WIDTH (C)	MAX DROP (D)	FABRIC
FC	5000	8000	A1 STD
EW 120	5000	7000	A1 120

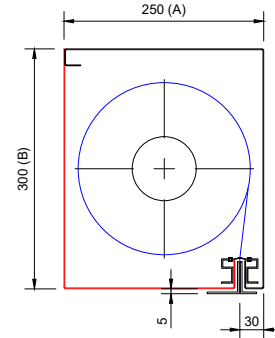

* SIZES GREATER THAN STATED PLEASE CONTACT A1S

Drawing Title: FLAMESHIELD EVO 1 S FIRE CURTAIN	Drawn By: DD
	Date: 18-11-2022
	Checked By: CE
	Date: 18-11-2022
All dimensions in millimetres - DO NOT SCALE	Drawing No: CD05R_01



A1 Shutters Limited
Jackson Works
Raikes Lane Industrial Estate
Bolton BL3 2NH
Telephone 01204 383839

FLAMESHIELD EVO 1 S FIRE CURTAIN GENERAL ARRANGEMENT DRAWING: REVEAL FIT

Key:
 — Components supplied by A1S Group
 — Structure already in situ / or required by others
 All openings must be capable of carrying the weight of the fire curtain and be equal or greater than the fire resistance of the fire curtain assembly.

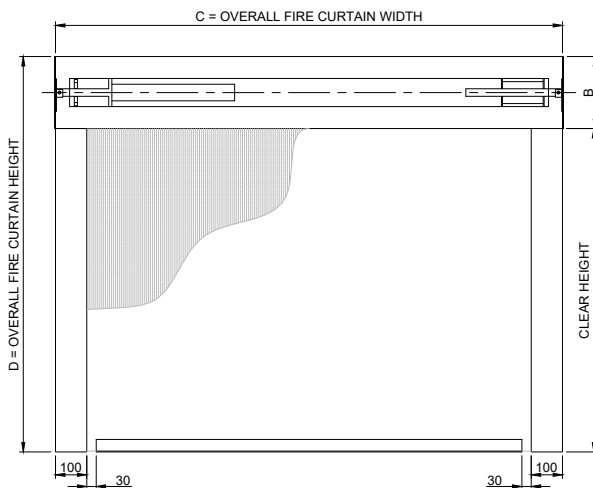

CD05R

Full width removable hood (Red) must be accessible for maintenance purposes

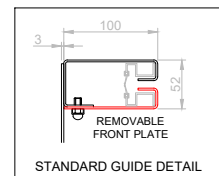
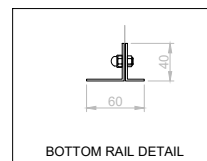
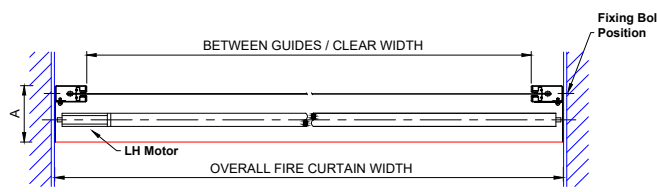
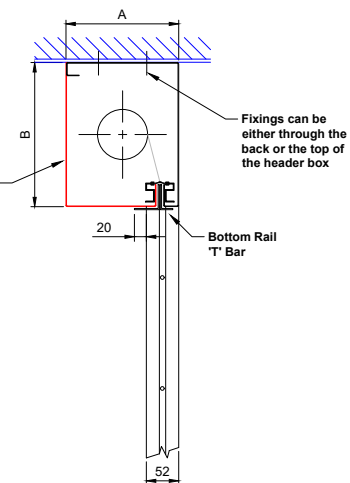

* ADDITIONAL SIZES AVAILABLE SUBJECT TO ASSESSMENT

Drawing Title: FLAMESHIELD EVO 1 S FIRE CURTAIN	Drawn By: DD
	Date: 18-11-2022
	Checked By: CE
	Date: 18-11-2022
All dimensions in millimetres - DO NOT SCALE	Drawing No: CD05R-02



A1 Shutters Limited
Jackson Works
Raikes Lane Industrial Estate
Bolton BL3 2NH
Telephone 01204 383839